

6127 Children's Big Book Displayer

Assembly Instructions

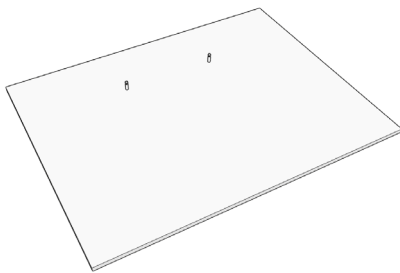

Parts Supplied:



1 x Back Panel 1165mm x 875mm

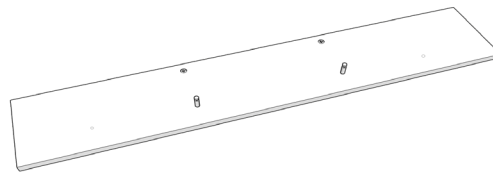

3 x Shelf Back Panel (screw in 2 x cam pins) 1165mm x 235mm

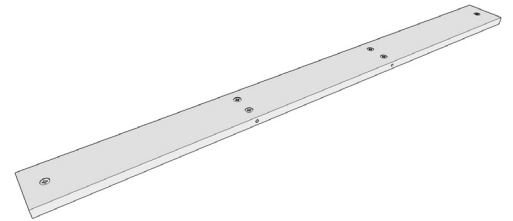

4 x Shelf Panels 1165mm x 95mm

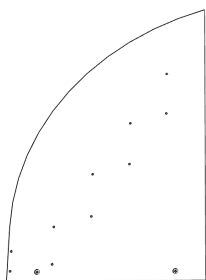

2 x Side panels 880mm x 600mm

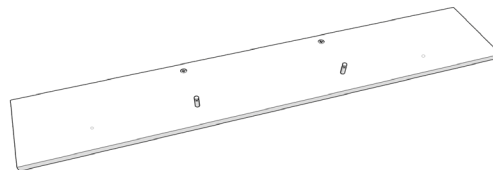

1 x Bottom Shelf (no screw holes on one side) 1165mm x 215mm



1 x Face Board 1165mm x 120mm

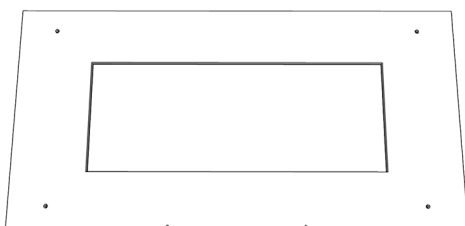

1 x Base Panel 1200mm x 600mm

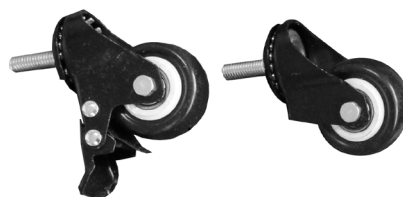

2 x locking castors + 2 x swivel castors

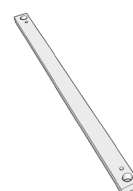

2 x steel (black) castor rails

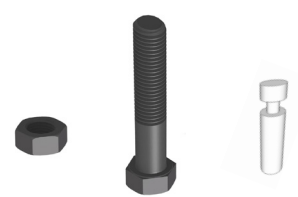

4 x nut and bolts cam pins

6127 Children's Big Book Displayer



www.walib.com.au

Step 2: Build Shelves

Step 1: screw in cam pins into holes

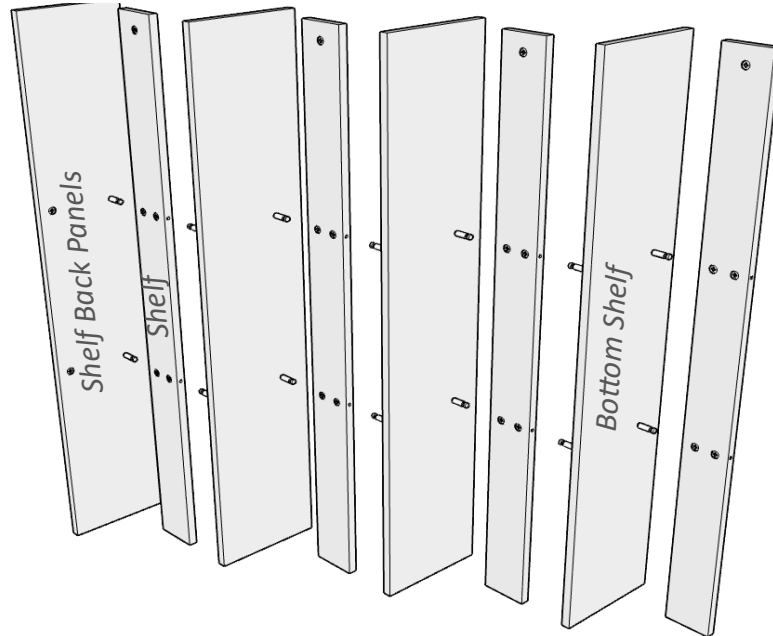
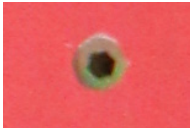

Push boards into cam pins and dowels.

Lock cam locks to secure.

Step 3: Attach Backboard to Shelves

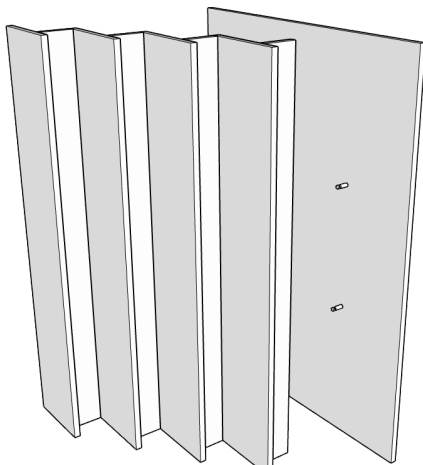

lock cam locks to secure

Step 4: Attach Side & Face Board

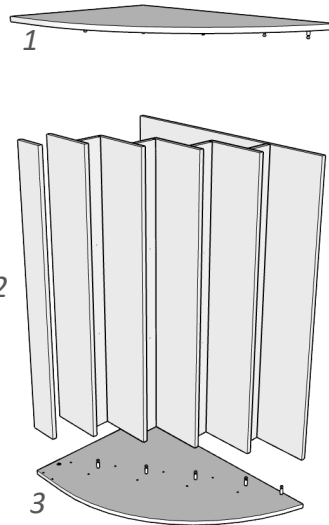

1. attach the first side panel.

2. attach the face board to the first side panel by pushing the face board into the dowels

3. turn bookcase over and attach the second side panel to the shelves and face board.

lock cam locks to secure

Step 5: Attach castors to base

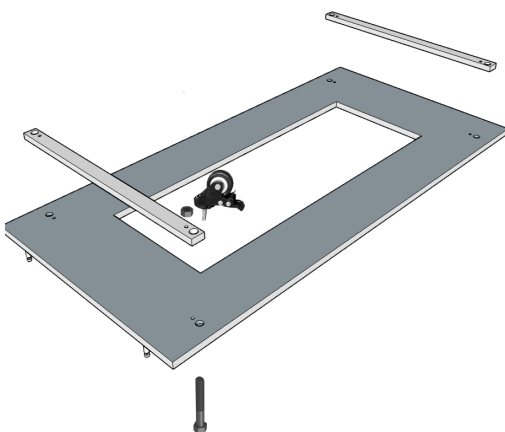

Secure castor rails to base with nut and bolt.

Screw castors to castor rail.

Step 6: Attach base panel

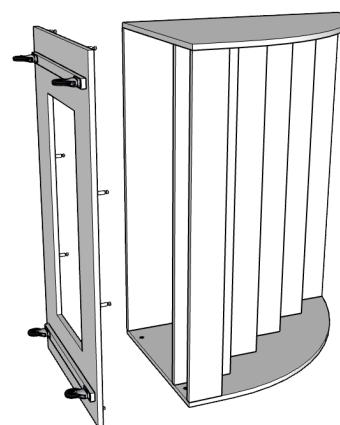

lock cam locks to secure